

K7-8 (300)		
No	a*b	X
2	716x296	1
3	268x290	1
4	268x300	2
5	720x300	1
6	720x300	1
7	716x297	1

K7-8 (500)		
No	a*b	X
2	716x496	1
3	468x290	1
4	468x300	2
5	720x300	1
6	720x300	1
7	716x497	1

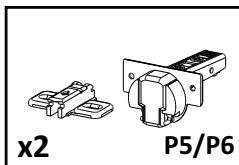

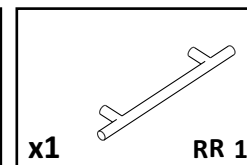
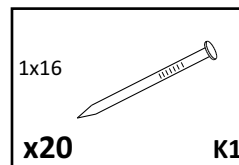
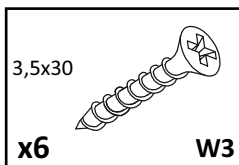
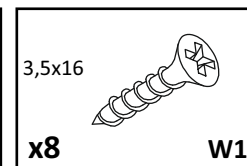
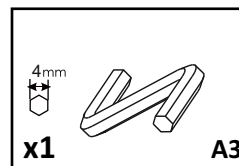
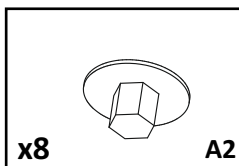
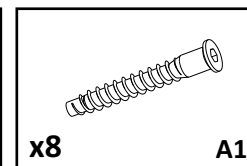
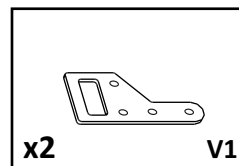
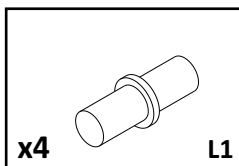
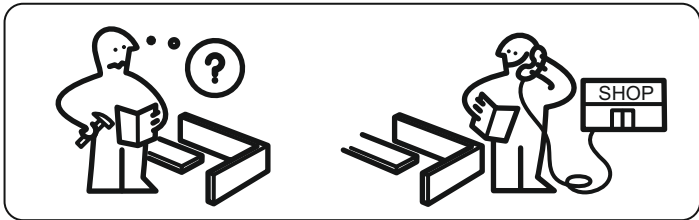
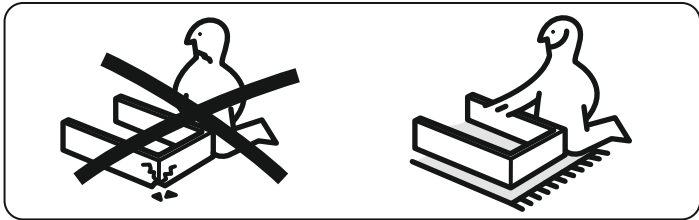
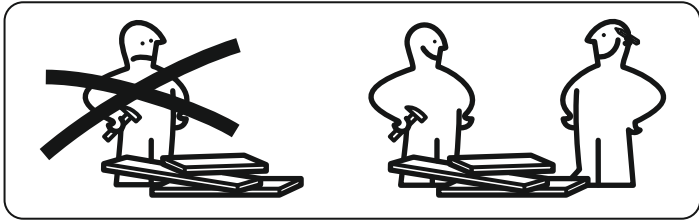
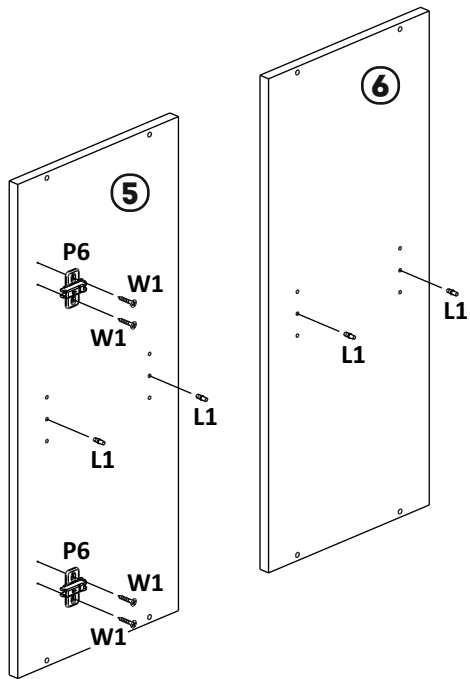
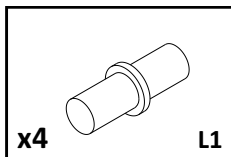
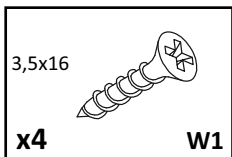
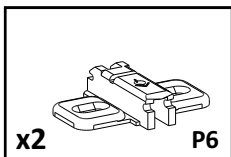
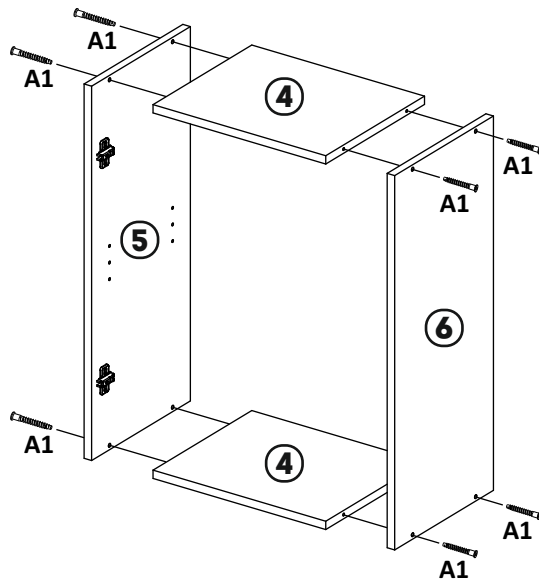
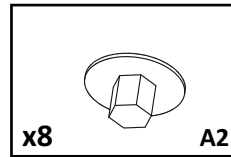
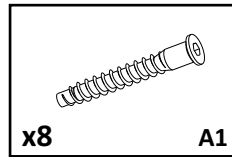

1**2**

3

1x16

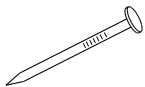

x20

K1

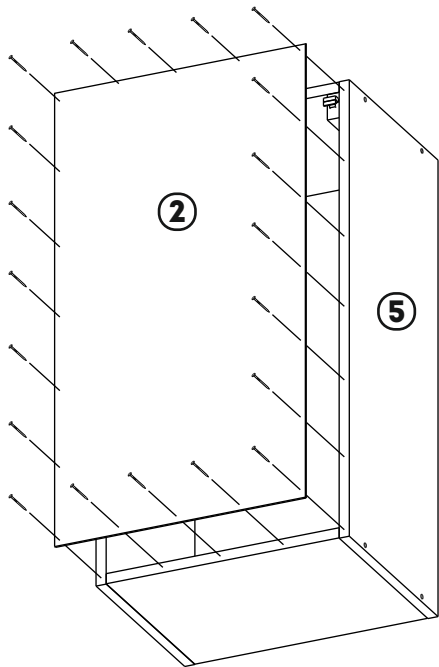
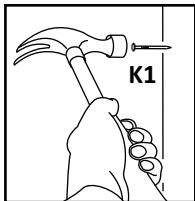

4

W1 (x3)
W3 (x1)

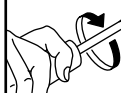

V1

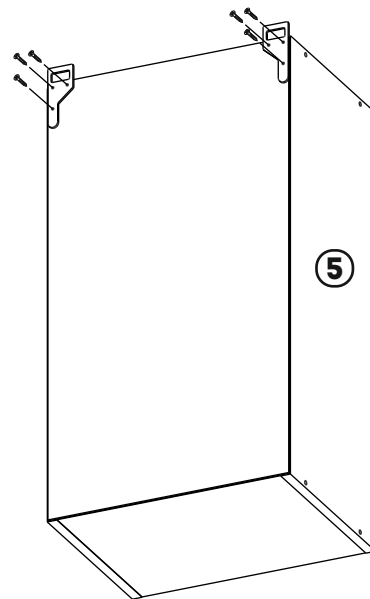
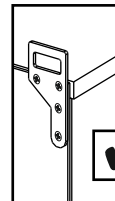

5

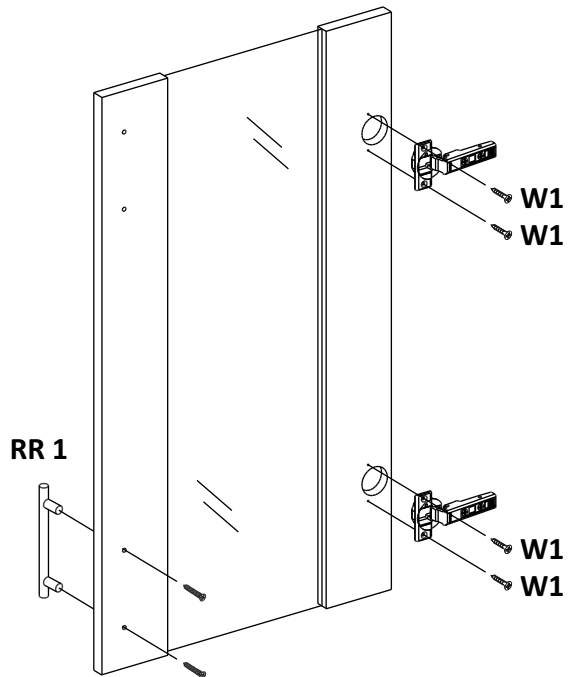
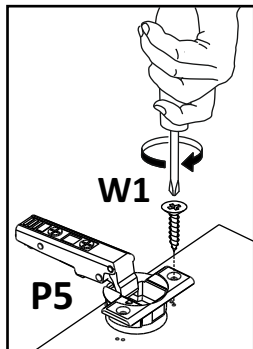
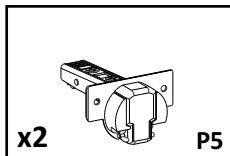
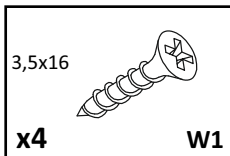
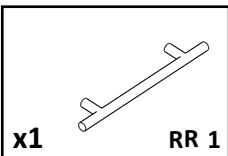

6

